

GD-067-0689-9W

9W medium performance adjustable LED track spot light with integrated LED chip and dimmable driver. Available in powder coated finish. 5-Years Warranty



671

LUMENS

9W

WATT

**3000K
4000K**

COLOUR

IP20

IP RATING

220-240V

AC

16/24/38°

BEAM ANGLE

**5
YEARS**

WARRANTY

DIMMABLE

DIMMING

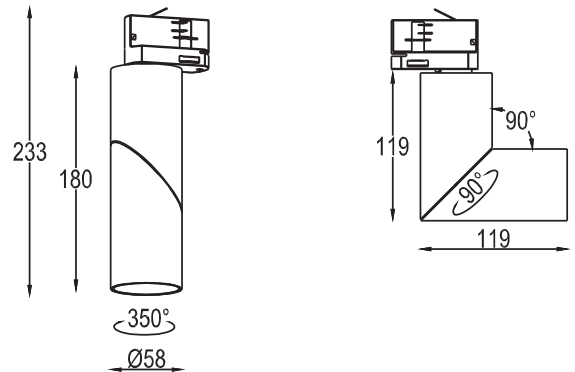

Model	IP Rating	Power (W)	Lumen Output (lm)	CCT	CRI	Beam Angle	Dimming	Dimensions	Mounting	Voltage	Fitting Colour
GD-067-0689-9W	IP20	9W	671lm	3000K 4000K	≥80	15° 24° 38°	Dimmable	Ø58x180 mm	Track	220-240V AC	Black White